

FLUID CONDUCTING QUICK DISCONNECT COUPLING

**SELF SEALING
5000 P.S.I.**

SIZES: 3/4 TO 3 INCH

HYDRAULICS *Inc.*

2935 ST. LOUIS AVENUE
FORT WORTH, TEXAS 76110



PRODUCT DATA — 5TV SERIES COUPLINGS

The 5TV series high pressure hydraulic coupling is designed for rugged hydrostatic drive applications in the mining and oil industries. Service in many such applications has proven the design compatible to extreme pressures, structural and system induced shockloads. The construction makes the coupling attractive in applications having low operating pressures. **NOTE** — Not for use with gaseous fluids.

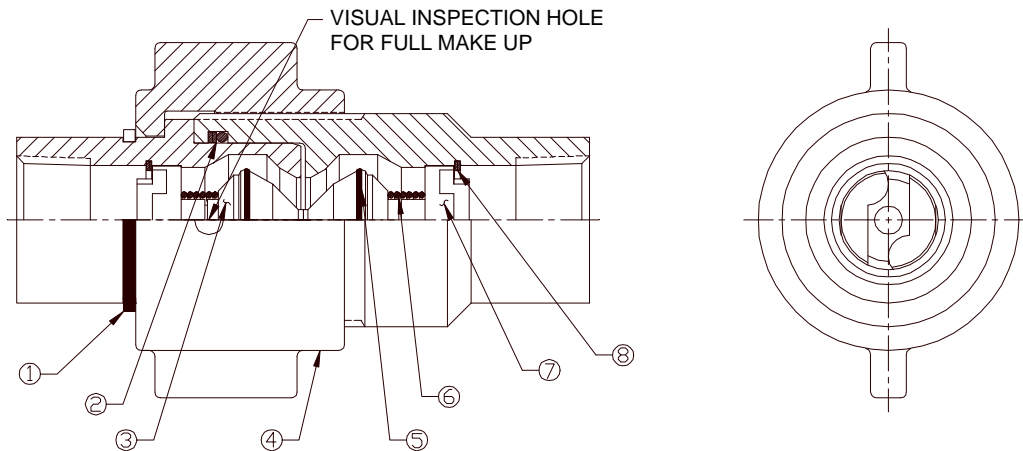

- | | |
|--|--|
| 1 NUT RETAINER RING | 5 VALVE SEAL SWAGED IN AGAINST WASHOUT |
| 2 NIPPLE SEAL (O-RING/BACK UP RING) | 6 VALVE SPRING |
| 3 POPPET VALVE | 7 EXCLUSIVE FOUR POINT CONTACT POPPET GUIDE |
| 4 HIGH STRENGTH CAST STEEL NUT | 8 2-TURN LOCK RING |

OPERATING LIMITS

- 5,000 P.S.I. operating pressure — all sizes
20,000 P.S.I. minimum burst — coupled
- Vacuum to 28" Hg
- Standard seal — temperature range — 40°F to +250°F
- Buna-N seals — standard

DESIGN FEATURES

- Excellent flow characteristics for continuous duty applications. See flow chart.
- High strength steel poppet guides prevent break up and washout of coupling valving during high surge and shock conditions.
- Exclusive four point support design of poppet guide provides positive alignment of valving during surging flow conditions
- Flat crested stub-acme threads and all steel construction withstand storage and rig-up damage.
- Protective treatment equal to industry standards for SAE steel hose fittings
- Structurally compatible with weight of 5,000 P.S.I. flex-hose and system induced shockloads.

SIZES AND CONNECTION TYPE

- 3/4" thru 3" — female NPTF pipe thread

PRESSURE DROP vs FLOW (GPM) —

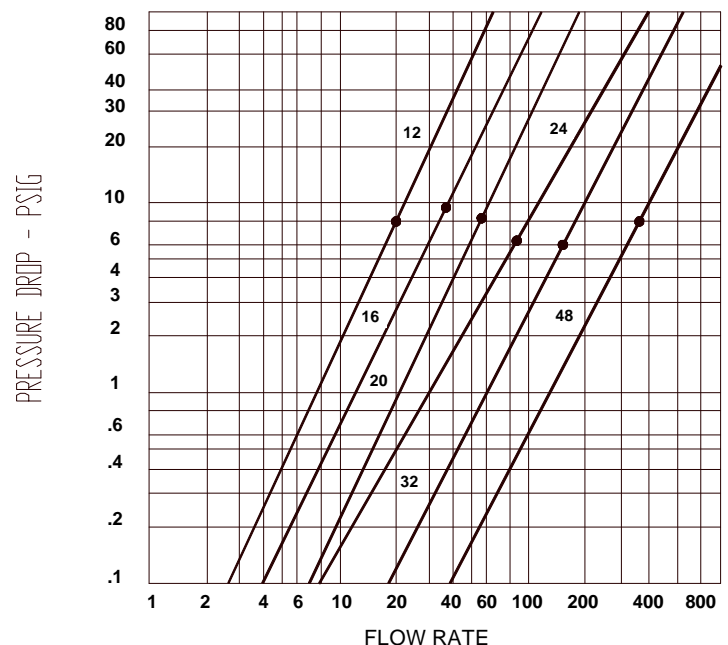

- Pressure drop thru coupling based on flow giving 15 FPS fluid velocity thru nominal bore size.



HIGH PRESSURE HYDRAULIC COUPLINGS

COUPLER

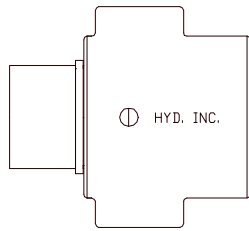

NIPPLE

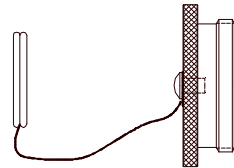
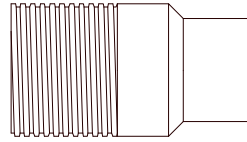

DUST PLUG

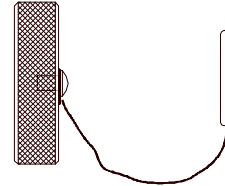

DUST CAP

ASSEMBLY PART NUMBERS					REPAIR PARTS PART NO.	
COUPLING PART NO.	NIPPLE PART NO.	COUPLER PART NO.	DUST PLUG PART NO.	DUST CAP PART NO.	VALVE ASS'Y *PART NO.	NIPPLE SEAL PART NO.
5TV-CN-12	5TV-N-12	5TV-C-12	5TV-DP-12	5TV-DC-12	5TV-VA-12	5TV-NS-12
5TV-CN-16	5TV-N-16	5TV-C-16	5TV-DP-16	5TV-DC-16	5TV-VA-16	5TV-NS-16
5TV-CN-20	5TV-N-20	5TV-C-20	5TV-DP-20	5TV-DC-20	5TV-VA-20	5TV-NS-20
5TV-CN-24	5TV-N-24	5TV-C-24	5TV-DP-24	5TV-DC-24	5TV-VA-24	5TV-NS-24
5TV-CN-32	5TV-N-32	5TV-C-32	5TV-DP-32	5TV-DC-32	5TV-VA-32	5TV-NS-32
5TV-CN-40	5TV-N-40	5TV-C-40	5TV-DP-40	5TV-DC-40	5TV-VA-40	5TV-NS-40
5TV-CN-48	5TV-N-48	5TV-C-48	5TV-DP-48	5TV-DC-48	5TV-VA-48	5TV-NS-48

*INCLUDES POPPET, POPPET GUIDE, SPRING AND RETAINER FOR ONE HALF ONLY

COUPLING PART NO.	DIMENSIONS				THREAD SIZES	WEIGHT POUNDS
	COUPLING LENGTH	NIPPLE LENGTH	COUPLER LENGTH	DIM. ACROSS WING NUT	FEMALE PIPE THREAD	"CN"
5TV-CN-12	4.86	3.27	2.84	3.00	¾-14	2
5TV-CN-16	6.05	4.18	3.35	3.75	1-11½	5
5TV-CN-20	7.75	5.35	4.42	4.50	1¼-11½	9
5TV-CN-24	8.62	5.97	5.02	4.75	1½-11½	14
5TV-CN-32	10.00	7.05	6.07	6.25	2-11½	28
5TV-CN-40	12.00	8.70	6.94	8.00	2½-8	65
5TV-CN-48	14.81	10.60	9.25	9.75	3-8	148

"Because of technological progress and product improvements, all design and dimensional data shown in this catalog is subject to change without notice. Technical information has been prepared from actual test results under controlled environmental conditions and data is considered to be reliable, but no responsibility can be assumed for its accuracy under varied field conditions."



HC-100



HC-104A



HC-103

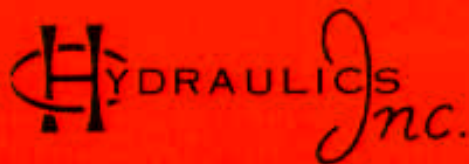

PLANT AND OFFICES:
2935 St. Louis Ave.
P. O. Box 5479
Fort Worth, TX 76115
Tel: 817-923-1965

CONTACT OUR FORT WORTH OFFICE FOR ADDITIONAL
PRODUCT INFORMATION • SWIVELS, COUPLINGS, AND
CONTROLS FOR HYDRAULIC SYSTEMS • ASK FOR THE
NEAREST REPRESENTATIVE.

Hydraulics Inc Quick Disconnect Coupling代理商

北京因科思公司——Increase International Company
北京朝阳区胜古中路2号金基业大厦201室邮编：100029
电话：010 - 8428 2935 ， 8428 3983 ， 8428 9077
传真：010 - 8428 8762 ， 139 1096 2635
Email：ownlevel@vip.sina.com
Website：Http://www.increaseinc.cn